

**TCA**

 **TICA**<sup>®</sup>  
[www.ticachina.com](http://www.ticachina.com)



# **MODULAR AIR-COOLED CHILLER (HEAT PUMP)**

**TICA CENTRAL AIR-CONDITIONING**

**CA-TCA-201609V01**



TICA is a hi-tech enterprise specialized in R&D, manufacturing, sales and services of air-conditioning and refrigeration products. Established in 1991, it has developed into one of the top four Chinese air-conditioning brands, with factories in Nanjing, Tianjin and Guangzhou, and a network of over 70 sales and service filiales around the world.

TICA has invested up to RMB 600 million in the first phase to build the top notch central air-conditioning R&D and production base, credited as the state enterprise R&D center. Certified by CNAS, it serves as a national R&D public service platform.

TICA produces over 30 series of products, covering AHUs, VRFs, screw chillers and centrifugal chillers, diverse enough to meet various requirements with regards to comfort and manufacturing processing application.

TICA is a strong competitor in chillers and commercial air conditioning products. It is the largest producer of AHUs in China for five consecutive years and covers over 40% of the market share as the supplier to such industries as micro-electronics, surgery operation room equipment and biopharmaceuticals.

TICA has established a global strategic joint venture with United Technologies Corporation (UTC) whose businesses include the world's most advanced Pratt & Whitney Aircraft Engines, the largest air-conditioning company Carrier and the biggest elevator company Otis.

The giant UTC transfers such global cutting-edge core technologies as large centrifugal chillers, screw chillers, and ORC systems to TICA, thrusting TICA 20 years ahead of its Chinese counterparts in terms of centrifuge technology and 30 years ahead in cryogenic power generation technology. Meanwhile, TICA and UTC will integrate global resources to create a brand-new international market pattern.

Meanwhile, the company has also provided energy-saving air-conditioning system integration solutions to both domestic and foreign users like Zhongnanhai, the Great Hall of the People, Beijing Bird's Nest stadium, the Water Cube, the Wukesong Indoor Stadium, Petro China, Sinopec, State Grid, Nanjing Panda, Hangzhou Xiaoshan Airport, Hainan Airlines Group, Shangri-La Hotel, Manila Ocean Park, Abu Dhabi Al Muneera, SM City in Philippines and Unilever, etc.



Nanjing Headquarter



Tianjin Base



Guangzhou Base

## DIRECTORY

PRODUCT NOMENCLATURE	1
TCA-XH	1
TCA-XHR	8
TCA-HHE	11
TCA-HCA	13
CAPACITY CORRECTION DATA	15
UNIT DIMENSION	17
FOUNDATION	19
ELECTRICAL WIRING DIAGRAM	22
INSTALLATION	23
UNIT HOISTING	23
WATER SYSTEM INSTALLATION	24
PRECAUTIONS FOR USERS	26



## PRODUCT NOMENCLATURE



The modular air-cooled chiller (heat pump) unit is a central air conditioning using the air as cold & heat source and the water as refrigerant carrier, which can be integrated with various air side units such as fan coil unit, air handling unit to form a central air conditioning system. With 20 years of experience in R&D, design and application, TICA constantly launches new environment-friendly modular units, which improves the structures, systems and programs based on original products, and designs special series of comfortable and technological units. The environment-friendly modular unit has complete functions and various specifications, with basic modules of any combination available for different models, including 66 kW, 100 kW, 130 kW, and at most 16 modules can be connected in parallel, providing combination products of 66 kW ~ 2080 kW. The unit is easy to install, with a system without cooling water, with simple pipelines, moderate cost, short construction period, allowing staged investment, widely applied in such commercial, industrial and civil buildings as villas, hotels, hospitals, office buildings, restaurants, supermarkets, movie theaters.

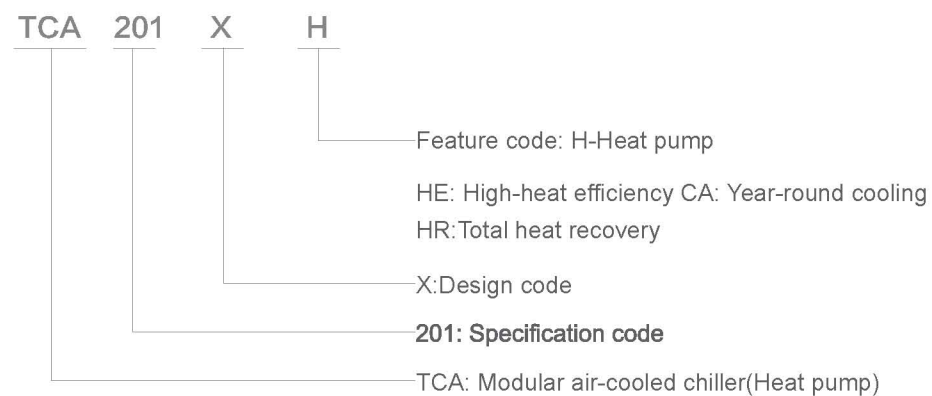

## R410A CLASSICAL MODULAR UNIT (TCA-XH)

The new generation of X series environment-friendly modular air-cooled unit is based on 20 years of experience in R&D and design, which is greatly improved in aspects of the structure, system and microcomputer control technology, providing wider operation range of refrigeration and heating, and higher adaptability to applications with requirements on comfort and technology. There are basic modules of any combination available for different models, including 66 kW, 100 kW, 130 kW, and at most 16 modules can be connected in parallel, providing combination products of 66 kW ~ 2080 kW.

### High Efficiency, Energy Saving And Environmental Protection

The water chiller unit is certified by CE, providing EER up to 3.1. The environment-friendly refrigerant R410A is stable and nontoxic with excellent performance and 0 ODP (ozone-depleting potential), doing no harm to the ozone layer.



### Excellent Capacity

Units of the same model or different models can be combined freely. Each group can combine up to 16 modules.



### Free master Module Design

Any single unit can operate as the master once connected with the wired controller. It overcomes the problem that the whole system would fail to work properly when the fixed master unit malfunctions.

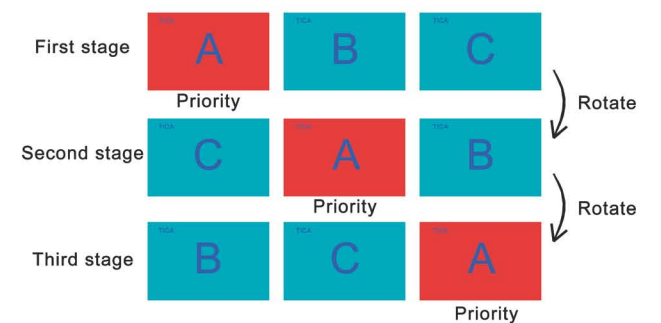



### Intelligent Defrosting Technology, Non-stop When Defrosting

The unit control system can determine whether defrosting is necessary according to the ambient temperature in heating mode, evaporating temperature and running time; when defrosting conditions are met, the unit will automatically activate the defrosting program to complete defrosting within a short time and provide heating operation efficiency up to over 90% , ensuring the optimum heating capacity and high EER.

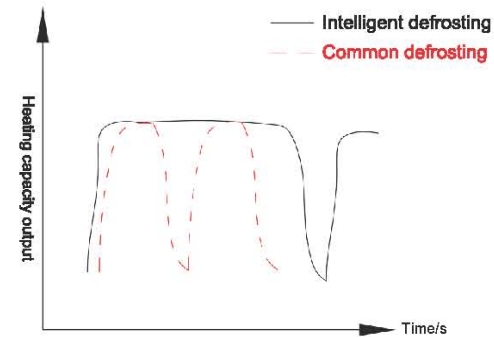

### Intelligent Air Volume Regulation

The shared duct system is adopted to greatly expand the operating range. The single-module unit can automatically increase or reduce fans based on the ambient temperature to achieve optimal matching between air volume and load and deliver outstanding performance.



### Intelligent Energy Regulation Technology

Unique intelligent energy regulation technology in multi-module combination ensures that each module loads or unloads a refrigerant circuit before loading or unloading other refrigerant circuits in the single module, thereby providing higher efficiency, stability and IPLV.

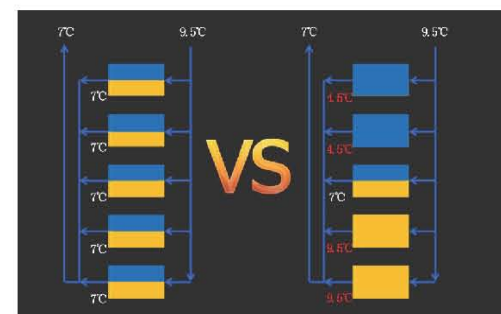

### Widely Operation Range

**Low temperature cooling**  
5°C~48°C

**High temperature heating**  
-15°C~48°C

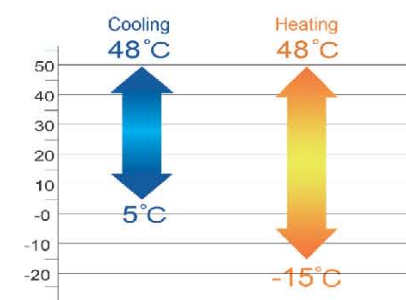

### Compact Design And Less Occupied Area

Unique and compact structure results in small size and occupied area, significant reductions in installation space and cost; the unit is compact and easy to install. A 130KW unit covers floor space of only 2.42m<sup>2</sup>, a 50% reduction compared to its equivalents.

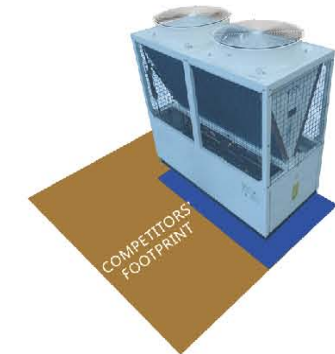

### Famous Hermetic Scroll Compressor

Unit adopt famous brand hermetic scroll compressor, which is high-efficient,energy saving and operates stably, with low noise,slight vibration and long service life.

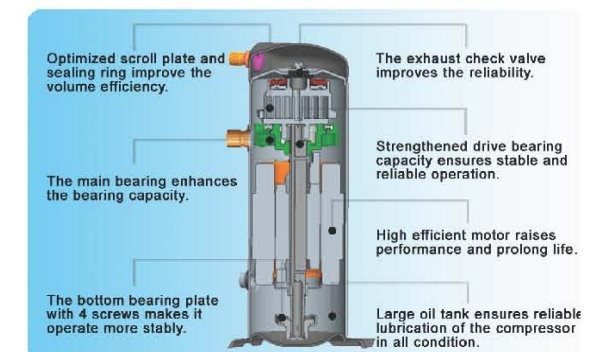

### V-Shaped Condenser

The v-shaped condenser has used an integral reinforcing metal frame, internal thread and triple anti-frosting features (patented design of open-window hydrophilic aluminum foil + bottom elevated + one-way valve), providing higher structural stability and corrosion resistance; with heat exchange efficiency improved through full use of heat exchange area, low tendency to dust accumulation and frosting in winter, low loss of pressure, smoother drainage and higher reliability.

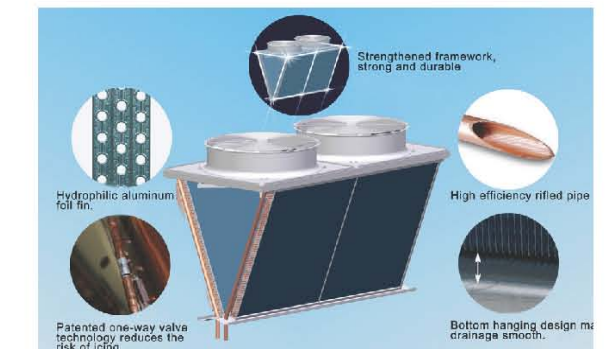

### Efficient Shell And Tube Heat Exchanger

The waterside efficient shell and internal thread heat exchanger is of helical baffle type, with better heat transfer performance and higher resistance to freezing than plate heat exchanger, lower water resistance and lower requirements for water quality.

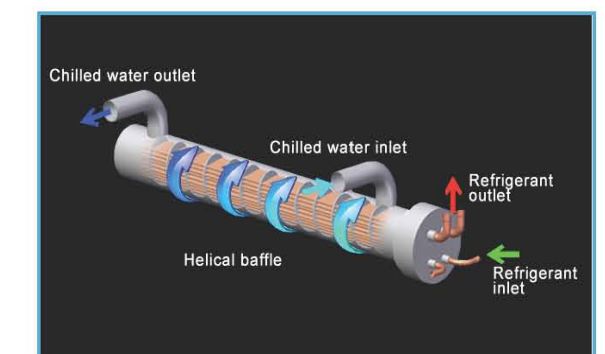



### Saw-shaped Impeller

Compared to plastic impellers, the saw-shaped impellers provide large air volume, high durability and high air supply efficiency with low noise.

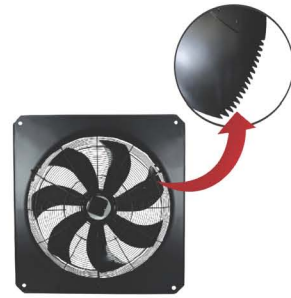

### High Precision Electronic Expansion Valve

The electronic expansion valve achieves 480 regulating range, supplemented by TICA's patented precision throttle control technology to realize dynamic matching in refrigerating system, fully improve the optimum efficiency of each component and ensure the optimum condition of system operation pressure and temperature.

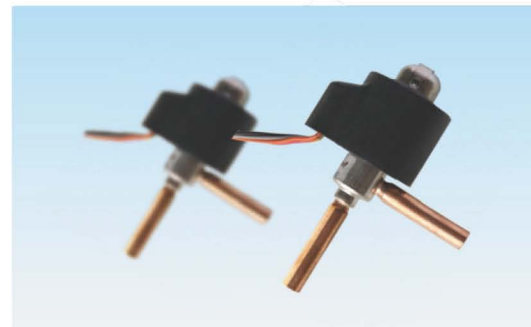

### Self-developed Microcomputer Control Panel

TCA control panel is fully upgraded based on original control panels with years of experience in R&D and design, which combines more functions including phase sequence detection, current detection, RS-485 communication interface, delivering stronger performance, utility, standardization, convenience and universality. The USB interface is also provided to facilitate later-stage maintenance and upgrade of control function. The panel is supplemented by TICA developed control program which offers full operation control and multiple safety protection functions.

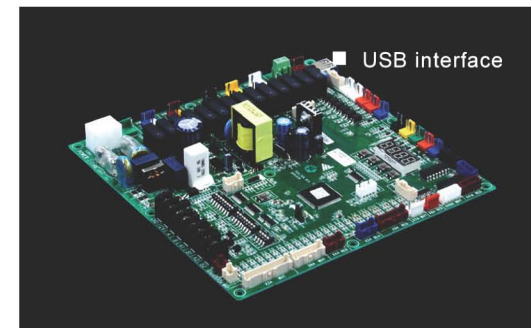

### Multiple Protection Functions, Providing Safety And Stability

The unit has multiple safety protection functions which ensure safety and stable operation of the unit and systems. The water flow switch and multiple anti-freezing program designs protect the unit and systems in an all-round way.

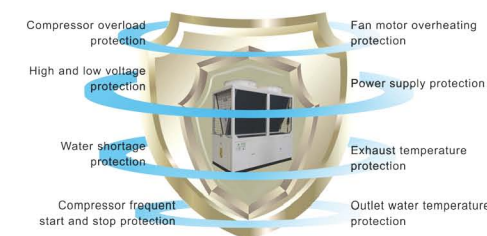

### Specifications

Model		TCA-201XH	TCA301XH	TCA-401XH
Cooling capacity	kW	66	100	130
	TR	18.8	28.4	37.0
Heating capacity	kW	70	110	140
	TR	19.9	31.3	39.8
Capacity adjustment	%	0-50-100		
Power supply*	-	380-415V 3N-50Hz		
Power input	Cooling kW	21.29	32.25	41.9
	Heating kW	21.85	34.37	43.7
Refrigerant	Type	R410A		
Compressor	Type	Hermetic scroll		
	Quantity	2	4	4
Water side heat exchanger	Type	High-efficient Shell and tube heat exchanger		
	Water flow m <sup>3</sup> /h	11.4	17.2	22.4
	Pressure drop kPa	45	30	45
	Pipe connection dimension	DN65(flanged joint)		
Air side heat exchanger	Type	High-efficient aluminum fin-copper Tube heat exchanger		
	Fan type	Axial-flow		
	Number of fans	2		
	Total fan air flow m <sup>3</sup> /h	28000	43000	48000
Sound pressure level	dB(A)	65	68	69
Dimension	Unit(LxWxH) mm	2200×860×2000	2200×1100×2205	2200×1100×2205
	Package(LxWxH) mm	2240×900×2000	2240×1140×2205	2240×1140×2205
Net weight	kg	580	900	1000
Gross weight	kg	585	905	1005
Operating weight	kg	640	980	1100
Optional auxiliary electric heating	kW	18	27	32

\*CE: 380-400V/3N/50Hz

### Combined Capacity Parameter Table(Total Heat Recovery)

Model and modular quantity	TCA201	1	2	3	4	5	6	7	8	9	10	11	12	13	14	15	16
Cooling capacity	kW	66	132	198	264	330	396	462	528	594	660	726	792	858	924	990	1056
Heating capacity	kW	70	140	210	280	350	420	490	560	630	700	770	840	910	980	1050	1120
Water flow volume	m <sup>3</sup> /h	11.4	22.8	34.2	45.6	57	68.4	79.8	91.2	102.6	114	125.4	136.8	148.2	159.6	171	182.4

Model and modular quantity	TCA301	1	2	3	4	5	6	7	8	9	10	11	12	13	14	15	16
Cooling capacity	kW	100	200	300	400	500	600	700	800	900	1000	1100	1200	1300	1400	1500	1600
Heating capacity	kW	110	220	330	440	550	660	770	880	990	1100	1210	1320	1430	1540	1650	1760
Water flow volume	m <sup>3</sup> /h	17.2	34.4	51.6	68.8	86	103.2	120.4	137.6	154.8	172	189.2	206.4	223.6	240.8	258	275.2

Model and modular quantity	TCA401	1	2	3	4	5	6	7	8	9	10	11	12	13	14	15	16
Cooling capacity	kW	130	260	390	520	650	780	910	1040	1170	1300	1430	1560	1690	1820	1950	2080
Heating capacity	kW	140	280	420	560	700	840	980	1120	1260	1400	1540	1680	1820	1960	2100	2240
Water flow volume	m <sup>3</sup> /h	22.4	44.8	67.2	89.6	112	134.4	156.8	179.2	201.6	224	246.4	268.8	291.2	313.6	336	358.4

Model	Cooling capacity	Compressor Number	Circulation loop	Main Board Number	Maximum Combination Number	Maximum Combination Capacity
TCA201XH	66	2	2	1	16	1040
TCA301XH	100	4	2	1	16	1600
TCA401XH	130	4	2	1	16	2080

★ Notes:

1. Nominal cooling operating conditions: leaving water temperature 7°C, ambient temperature 35°C; Nominal heating operating conditions: leaving water temperature 45°C, outdoor dry bulb temperature 7°C, wet bulb temperature 6°C.
2. In actual use, the cooling/heating loss should be considered after the in stallation of the system piping, pumps, valve, dirt, etc. about 6%.
3. For other working conditions or capacity parameters, Please contact TICA offices for cooling ambient condition under 5°C.
4. There will be no further notice if the parameters changes due to product optimization.
5. The units of the same model or different models can be combined freely. Each system can combine up to 16 modules.
6. The controllers need to be ordered separately, including wired controller, communication line, IOM, temperature sensor. Manufacturer reserves the right to make changes to above specifications without prior notice, please refer to the factory configuration when purchasing.

## TOTAL HEAT RECOVERY MODULAR UNIT (TCA-XHR)

TICA's total heat recovery modular air-cooled chiller (heat pump) unit uses the environment-friendly refrigerant R410A and combines the features of TICA air-cooled chiller (heat pump) unit and air-source heat pump water heater unit. It has five modes: A/C cooling, A/C heating, heat recovery, heat pump water heating, A/C heating + heat pump water heating, widely applied in places requiring central air conditioning and water heating, such as hotels, schools, restaurants, hospitals, villas, bath centers.

### Free Domestic Hot Water

In the A/C cooling mode, the unit can recover waste heat and provide free domestic hot water up to 55°C. The unit replaces the boiler to meet the user needs for hot water, saves initial investment, eliminates the need for machine room, and saves the building area and energy for environmental protection.



### Less Occupied Area

A single module covers a floor area of only 1.89 m<sup>2</sup> which is the smallest in the industry, leaving larger valuable space for customers. The unit can substitute the boiler, eliminates the need for machine room, and saves initial investment and building area.



### Compact Design And Complete Functions

The compact structural design does not impair strong functions and five modes are more widely applied, including refrigeration, heating, heat recovery, heat pump water heating, A/C heating + heat pump water heating.

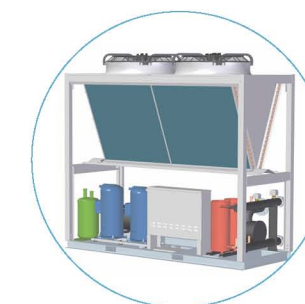

### Efficient Components Providing Higher Efficiency

The unit employs efficient shell and tube heat exchanger, fan, and heat recovery unit, with optimized pipeline design, providing comprehensive energy efficiency up to 8.24 under conditions of cooling + heat recovery.

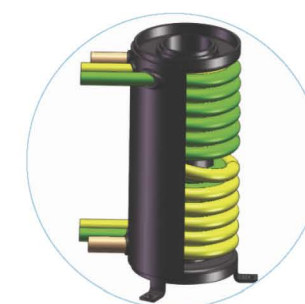



## TOTAL HEAT RECOVERY OPERATION MODE

There are five operation modes including cooling, heat recovery, A/C heating, heat pump water heating, heating + heat pump water heating, which satisfy the user needs for air conditioning throughout the year and provide domestic hot water.

### Cooling Mode

In summer or transition season needing cooling but not hot water, this mode can be used. In such case, the unit operates for cooling only, just like a standard air-cooled heat pump unit.

### Heat Recovery Mode

In circumstances where both cooling and production of domestic hot water are needed, this mode can be used. In such case, the unit automatically selects the optimal operation mode based on the needs for air conditioning and water heating to produce chilled water for air conditioning and domestic hot water for everyday use.

### Heat Pump Water Heating Mode

In circumstances where only domestic hot water is needed instead of cooling or heating, this mode can be used. In such case, the unit only provides domestic hot water, just like a standard airsource heat pump water heater unit.

### Heating Mode

In circumstances where only domestic hot water is needed instead of cooling or heating, this mode can be used. In such case, the unit only provides domestic hot water, just like a standard airsource heat pump water heater unit.

### Heating + Heat Pump Water Heating Mode

In winter or other circumstances where both heating and domestic hot water are needed, this mode can be used. In such case, the water heating mode is preferred by default to ensure use of domestic hot water; then at the "idle time" when the demand for hot water is satisfied, the unit automatically switches to the heating mode to meet the needs for heating. Users may set the heating mode as the priority as required to ensure heating effect.

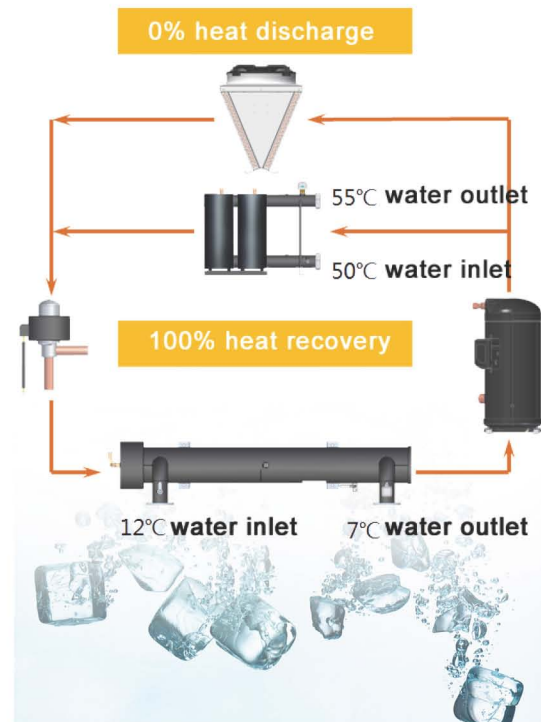

## Specifications

Model		TCA-201XHR	
Cooling mode	Cooling capacity	kW	66
	Heating capacity	kW	70
	Cooling power input	kW	20
	Heating power input	kW	21
	Water flow volume	m <sup>3</sup> /h	11.4
Heating water mode	EER	-	3.3
	Water flow volume	m <sup>3</sup> /h	13.1
	Heating capacity	kW	76
	Heating power input	kW	18.4
Cooling mode+Heat recovery mode	Water production volume	m <sup>3</sup> /h	1.63
	Cooling capacity	kW	60
	Heat recovery capacity	kW	76
	Power input	kW	16.5
	Water production volume	m <sup>3</sup> /h	1.63
Cooling mode+Heat recovery mode	Cooling water flow volume	m <sup>3</sup> /h	10.3
	Heating water flow volume	m <sup>3</sup> /h	13.1
	Power supply	-	380-415V/3N/50Hz
Pressure drop	Cooling water	kPa	18
	Heating water	kPa	50
connection pipe	Cooling water	-	DN65(Flanged connection)
	Heating water	-	DN65(Internal thread)
Fan	Type	-	Axial-flow
	Number	-	2
	Air flow	m <sup>3</sup> /h	28000
Compressor	Type	-	Hermetic scroll
	Quantity	-	2
Refrigerant	Type	-	R410A
Dimension	Unit(LxWxH)	mm	2200×860×2000
	Package(LxWxH)	mm	2240×900×2000
Net weight		kg	700
Gross weight		kg	705
Operating weight		kg	760

## Combined Capacity Parameter Table

Model and modular quantity	TCA 201XHR	1	2	3	4	5	6	7	8	9	10	11	12	13	14	15	16
Cooling capacity	kW	66	132	198	264	330	396	462	528	594	660	726	792	858	924	990	1056
Heating capacity	kW	70	140	210	280	350	420	490	560	630	700	770	840	910	980	1050	1120
Heating capacity (Hot water)	kW	76	152	228	304	380	456	532	608	684	760	836	912	988	1064	1140	1216
Water flow	m <sup>3</sup> /h	11.4	22.8	34.1	45.5	56.9	68.3	79.7	90.8	102.4	113.8	125.2	136.6	147.6	158.9	170.3	181.6
Water flow (Hot water)	m <sup>3</sup> /h	13.1	26.2	39.3	52.4	65.5	78.6	91.7	104.8	117.9	131	144.1	157.2	170.3	183.4	196.5	209.6

★ Note:

- Cooling mode: Nominal cooling operating conditions: water flow volume 11.4m<sup>3</sup>/h, chilled water outlet temperature 7°C, ambient temperature 35°C. Nominal heating operating conditions: water flow 11.4m<sup>3</sup>/h, hot water outlet temperature 45°C, ambient dry/wet bulb temperature 7°C/6°C.
- Heating water mode: Nominal conditions: water flow volume 13.1m<sup>3</sup>/h, hot water outlet temperature 45°C, ambient dry/wet bulb temperature 20/15°C.
- Cooling + heat recovery mode: Nominal cooling operating conditions: cooling water flow volume 10.3m<sup>3</sup>/h, chilled/hot water temperature 7/45°C, hot water water flow volume 13.1m<sup>3</sup>/h, hot water outlet temperature 45°C.
- Nominal heating operating conditions: initial water temperature 15°C, cadence water temperature 55°C, ambient dry/wet bulb temperature 20/15°C.
- In actual use, the cooling/heating loss should be considered after the installation of the system piping, pumps, valve, dirt, etc. about 6%.
- The units can be combined freely. Each system can combine up to 16 modules.
- There will be no further notice if the parameters changes due to product optimization.
- The controllers need to be ordered separately, including wired controller, communication line, IOM, temperature sensor. Manufacturer reserves the right to make changes to above specifications without prior notice, please refer to the factory configuration when purchasing.



## HIGH-HEAT EFFICIENCY MODULAR UNIT (TCA-HHE)

The unit is designed with TICA's experience in R&D of modular unit, featuring the most advanced EVI compressor from EMERSON and applicable for a wider range of heating.

### Widely Operation Range Of Heating

The advanced EVI compressor technology is adopted for twostage compression, wider operation range of efficient heating at ambient temperature of -25°C~25°C to satisfy a wider range of requirements.

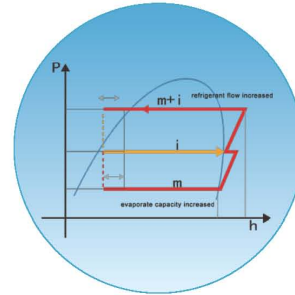

### Precision Throttle Control Technology Of Electronic EXV

The electronic expansion valve achieves 480 regulating range, supplemented by TICA's patented precision throttle control technology to realize dynamic matching in refrigerating system, fully improve the optimum efficiency of each component and ensure the optimum condition of system operation pressure and temperature.

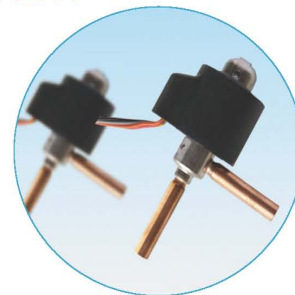

### EVI Compressor

The high-heat efficiency modular unit employs the efficient EVI technology, with a secondary suction port fitted on the scroll plate. The refrigerant volume is increased through the secondary suction loop and the enthalpy difference of refrigerant in the major cycle is increased to improve the efficiency of cooling and heating.

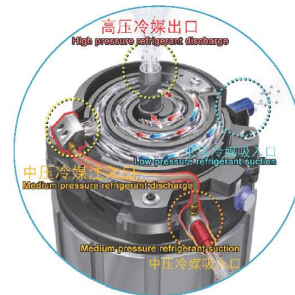

### Low Carbon And Environmental Protection

The unit uses the environment-friendly refrigerant R410A, and combines air source heat pump and EVI technologies. It can be used in the northern area for cooling in summer and heat pump heating in winter, providing lower-carbon and more environment-friendly applications.



## Specification(High-Heat Efficiency)

Model			TCA-201HHE
Cooling capacity		kW	66
Heating capacity		kW	70
Power input	Cooling	kW	20
	Heating	kW	21
Capacity adjustment		%	0-50-100
Power supply		-	380-415V/3N/50Hz
Water side	Water flow volume	m <sup>3</sup> /h	11.4
	Pressure drop	kPa	45
	connection pipe	-	DN65(Flanged connection)
Compressor	Type	-	Hermetic scroll
	Quantity	-	2
Fan	Type	-	Axial-flow
	Number	-	2
	Air flow volume	m <sup>3</sup> /h	24000
Refrigerant	Type	-	R410A
	Unit(LxWxH)	mm	2206×1030×2144
Dimension	Package(LxWxH)	mm	2246×1070×2144
	Net weight	kg	740
Gross weight		kg	745
Operating weight		kg	799
Optional auxiliary electric heating		kW	15

## Combined Capacity Parameter Table(High-Heat Efficiency)

Model and modular quantity	TCA201HHE	1	2	3	4	5	6	7	8	9	10	11	12
Cooling capacity	kW	66	132	198	264	330	396	462	528	594	660	726	792
Heating capacity	kW	70	140	210	280	350	420	490	560	630	700	770	840
Water flow volume	m <sup>3</sup> /h	11.4	22.8	34.2	45.6	57	68.4	79.8	91.2	102.6	114	125.4	136.8

#### ★ Notes:

- Nominal cooling operating conditions: leaving water temperature 7°C, ambient temperature 35°C; Nominal heating operating conditions: leaving water temperature 45°C, outdoor dry bulb temperature 7°C, wet bulb temperature 6°C;
- In actual use, the cooling/heating loss should be considered after the installation of the system piping, pumps, valve, dirt, etc. about 6%;
- For other working conditions or capacity parameters, Please contact TICA offices for cooling ambient condition under 5°C;
- There will be no further notice if the parameters changes due to product optimization.
- The units can be combined freely. Each system can combine up to 12 modules.
- The controllers need to be ordered separately, including wired controller, communication line, IOM, temperature sensor. Manufacturer reserves the right to make changes to above specifications without prior notice, please refer to the factory configuration when purchasing.



## YEAR-ROUND COOLING MODULAR UNIT (TCA-HCA)

TICA's new generation of year-round cooling modular unit is applicable for industrial applications, and requirements on energy saving and environment protection. It can operate for refrigeration at the ambient temperature of -10°C ~ 48°C all the year round, with environment-friendly refrigerant R410A, advanced electronic expansion valve control technology, efficient shell and tube heat exchanger, EC fan with stepless speed regulation, fully meeting the requirements of various industry applications for chilled water throughout the year.

### Widely Operation Range Of Heating

The modular water chiller unit is specially designed and can run in all weathers at the ambient temperature of -10°C~48°C.

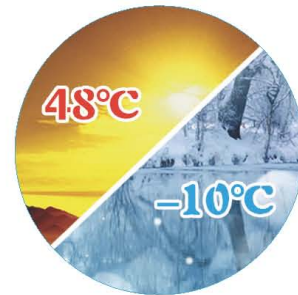

### DC Fan With Stepless Speed Regulation

The condensate fan employs the DC brushless motor of which the speed is variable between 20%-100% to ensure that condensing pressure is within the range of safe operation under all conditions for longer service life.



### High Precision Electronic Expansion Valve

The electronic expansion valve achieves 480 regulating range, supplemented by TICA's patented precision throttle control technology to realize dynamic matching in refrigerating system, fully improve the optimum efficiency of each component and ensure the optimum condition of system operation pressure and temperature.

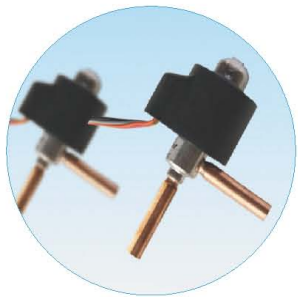

### Dry-type Shell And Tube Heat Exchanger

The unit employs efficient dry-type heat exchanger as the waterside heat exchanger which has excellent anti-freezing performance and higher tolerance to impurities in water system, ensuring more reliable and stable operation of the unit.



## Specification(Year-round Cooling)

Model		TCA-201HCA	
Cooling capacity		kW	66
Power input		kW	20
Capacity adjustment		%	0-50-100
Power supply		-	380-415V/3N/50Hz
Water side	Water flow volume	m³/h	11.4
	Pressure drop	kPa	45
	connection pipe	-	DN65(Flanged connection)
Compressor	Type	-	Hermetic scroll
	Quantity	-	2
Fan	Type	-	Axial-flow
	Number	-	2
	Air flow volume	m³/h	24000
Refrigerant	Type	-	R410A
	Unit(LxWxH)	mm	2206×1030×2144
Dimension	Package(LxWxH)	mm	2246×1070×2144
	Net weight	kg	740
Gross weight		kg	745
Operating weight		kg	799

## Combined Capacity Parameter Table(Year-round Cooling)

Model and modular quantity	TCA 201HCA	1	2	3	4	5	6	7	8	9	10	11	12
Cooling capacity	kW	66	132	198	264	330	396	462	528	594	660	726	792
Water flow volume	m³/h	11.4	22.8	34.2	45.6	57	68.4	79.8	91.2	102.6	114	125.4	136.8

★ Notes:

- Nominal cooling operating conditions: leaving water temperature 7°C, ambient temperature 35°C;
- In actual use, the cooling/heating loss should be considered after the installation of the system piping, pumps, valve, dirt, etc. about 6%;
- For other working conditions or capacity parameters, Please contact TICA;
- There will be no further notice if the parameters changes due to product optimization.
- The units can be combined freely. Each system can combine up to 12 modules.
- The controllers need to be ordered separately, including wired controller, communication line, IOM, temperature sensor. Manufacturer reserves the right to make changes to above specifications without prior notice, please refer to the factory configuration when purchasing.



## CAPACITY CORRECTION FACTOR

### Cooling Capacity Correction Factor

Leaving Water Temperature °C	Ambient Temperature °C																	
	5		10		15		20		25		30		35		40		48	
	Cooling	Power input	Cooling	Power input	Cooling	Power input	Cooling	Power input	Cooling	Power input	Cooling	Power input	Cooling	Power input	Cooling	Power input	Cooling	Power input
5	1.06	0.72	1.08	0.73	1.09	0.71	1.09	0.78	1.04	0.84	0.99	0.90	0.93	0.97	0.87	1.01	0.80	1.08
7	1.14	0.75	1.16	0.76	1.17	0.74	1.16	0.81	1.11	0.87	1.06	0.93	1.00	1.00	0.94	1.04	0.87	1.11
9	1.21	0.78	1.23	0.79	1.24	0.77	1.23	0.84	1.18	0.90	1.13	0.96	1.07	1.03	1.01	1.07	0.94	1.14
12	1.28	0.81	1.30	0.82	1.31	0.80	1.30	0.87	1.25	0.93	1.20	0.99	1.14	1.06	1.08	1.10	1.01	1.17
15	1.35	0.84	1.37	0.85	1.38	0.83	1.37	0.90	1.32	0.96	1.27	1.02	1.21	1.09	1.15	1.13	1.08	1.20

★ Note: Above Correction Factor adapt to TCA201/301/401XH, TCA201HHE, TCA201XHR.

### Heating Capacity Correction Factor

Leaving Water Temperature °C	Ambient Temperature °C																	
	-15		-10		-5		0		7		10		15		20		25	
	Heating	Power input	Heating	Power input	Heating	Power input	Heating	Power input	Heating	Power input	Heating	Power input	Heating	Power input	Heating	Power input	Heating	Power input
35	0.48	0.77	0.63	0.78	0.74	0.79	0.87	0.85	1.03	0.89	1.05	0.91	1.10	0.93	1.15	0.95	1.20	0.97
40	0.46	0.83	0.61	0.84	0.72	0.85	0.85	0.91	1.01	0.95	1.03	0.97	1.08	0.99	1.13	1.01	1.18	1.03
45	-	-	0.60	0.89	0.71	0.90	0.84	0.96	1.00	1.00	1.01	1.03	1.06	1.05	1.11	1.07	1.16	1.09

★ Note: Above Correction Factors adapt to TCA201/301/401XH, TCA201XHR.

### Year-round Cooling Capacity Correction Factor

Leaving Water Temperature °C	Ambient Temperature °C																	
	-10		-5		0		7		15		25		35		48			
	Cooling	Power input	Cooling	Power input	Cooling	Power input	Cooling	Power input	Cooling	Power input	Cooling	Power input	Cooling	Power input	Cooling	Power input		
0	1.01	0.65	0.99	0.73	0.97	0.69	0.96	0.69	0.98	0.72	0.92	0.82	0.84	0.94	0.68	1.12		
5	1.11	0.68	1.09	0.76	1.07	0.72	1.06	0.72	1.08	0.75	1.02	0.85	0.94	0.97	0.78	1.15		
7	1.17	0.71	1.15	0.79	1.13	0.75	1.12	0.75	1.14	0.78	1.08	0.88	1.00	1.00	0.84	1.18		
10	1.25	0.75	1.23	0.83	1.21	0.79	1.20	0.79	1.22	0.82	1.16	0.92	1.08	1.04	0.92	1.22		
15	1.35	0.80	1.33	0.88	1.31	0.84	1.30	0.84	1.32	0.87	1.26	0.97	1.18	1.09	1.02	1.27		
20	1.43	0.84	1.41	0.92	1.39	0.88	1.38	0.88	1.40	0.91	1.34	1.01	1.26	1.13	1.10	1.31		

★ Note: Above Correction Factors adapt to TCA201HCA.

### High-heat Efficient Heating Capacity Correction Factor

Leaving Water Temperature °C	Ambient Temperature °C											
	-25		-20		-15		-10		-5		0	
	Heating	Power input	Heating	Power input	Heating	Power input	Heating	Power input	Heating	Power input	Heating	Power input
35	0.42	0.75	0.52	0.76	0.60	0.77	0.69	0.78	0.79	0.79	0.87	0.85
40	0.40	0.80	0.49	0.81	0.58	0.82	0.67	0.83	0.77	0.84	0.85	0.90
45	-	-	-	-	-	-	0.65	0.89	0.75	0.90	0.84	0.96

Leaving Water Temperature °C	Ambient Temperature °C											
	0		7		10		15		20		25	
	Heating	Power input	Heating	Power input	Heating	Power input	Heating	Power input	Heating	Power input	Heating	Power input
35	0.87	0.85	1.03	0.89	1.05	0.91	1.09	0.92	1.14	0.94	1.19	0.93
40	0.85	0.90	1.01	0.94	1.03	0.96	1.07	0.97	1.12	0.99	1.17	0.99
45	0.84	0.96	1.00	1.00	1.01	1.01	1.05	1.02	1.10	1.04	1.15	1.05

★ Note: Above Correction Factors adapt to TCA201HHE.

### Cooling+heat Recovery capacity Correction Factor

Hot Water Temperature °C	Chilled Water Temperature °C											
	°C			8			9			10		
	Cooling	Heat recovery capacity	Power input	Cooling	Heat recovery capacity	Power input	Cooling	Heat recovery capacity	Power input	Cooling	Heat recovery capacity	Power input
35	1.14	1.03	0.83	1.16	1.05	0.83	1.19	1.08	0.84	1.23	1.11	0.85
40	1.11	1.03	0.95	1.14	1.04	0.95	1.18	1.07	0.95	1.20	1.11	0.95
45	1.00	1.00	1.00	1.05	1.03	1.02	1.11	1.07	1.04	1.17	1.10	1.06
50	0.99	0.99	1.15	1.03	1.02	1.15	1.07	1.05	1.16	1.12	1.09	1.17
55	0.97	0.99	1.25	1.02	1.01	1.26	1.04	1.04	1.26	1.08	1.07	1.27

★ Note: Above Correction Factors adapt to TCA201XHR.

### Heating Water Capacity Correction Factor

Hot Water Temperature °C	Ambient Temperature °C											
	°C		-5		0		5		10		15	
	Heating	Power input	Heating	Power input	Heating	Power input	Heating	Power input	Heating	Power input	Heating	Power input
35	0.49	0.81	0.57	0.82	0.61	0.83	0.78	0.84	0.96	0.86	0.96	0.88
40	0.48	0.88	0.56	0.89	0.60	0.91	0.74	0.91	0.88	0.91	0.98	0.92
45	—	—	0.54	0.97	0.60	0.98	0.73	0.98	0.85	0.99	0.96	0.99
50	—	—	—	—	0.61	1.10	0.73	1.10	0.84	1.11	0.96	1.13
55	—	—	—	—	—	—	0.72	1.21	0.84	1.21	0.96	1.22

★ Note: Above Correction Factors adapt to TCA201XHR.



UNIT DIMENSION(mm)

TCA201XH

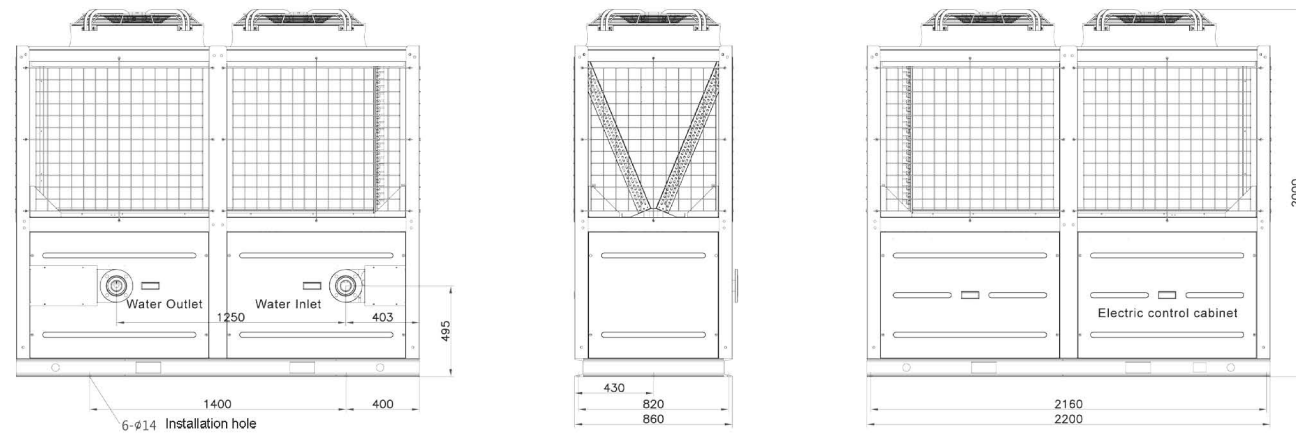

TCA201XHR

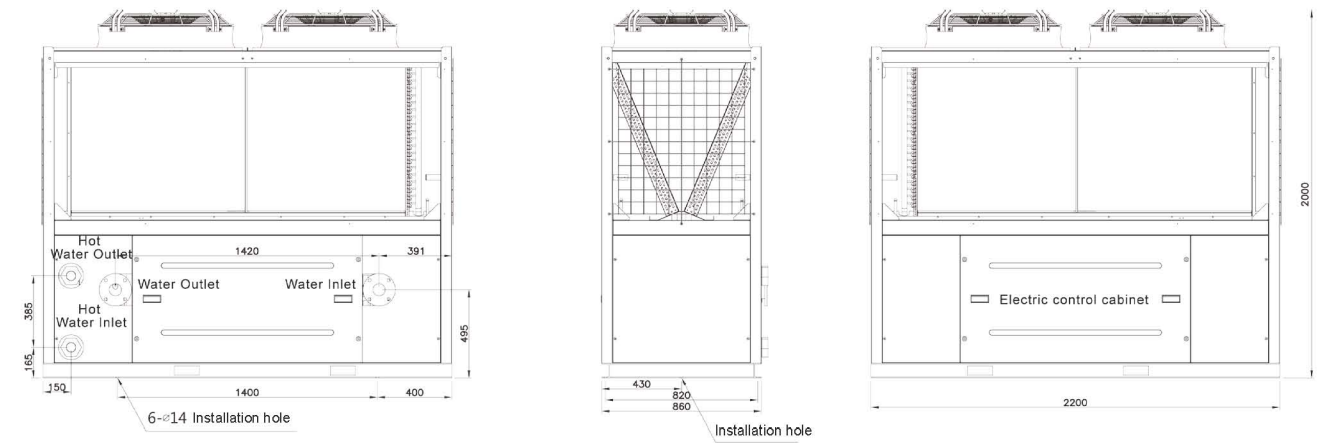

TCA301/401XH

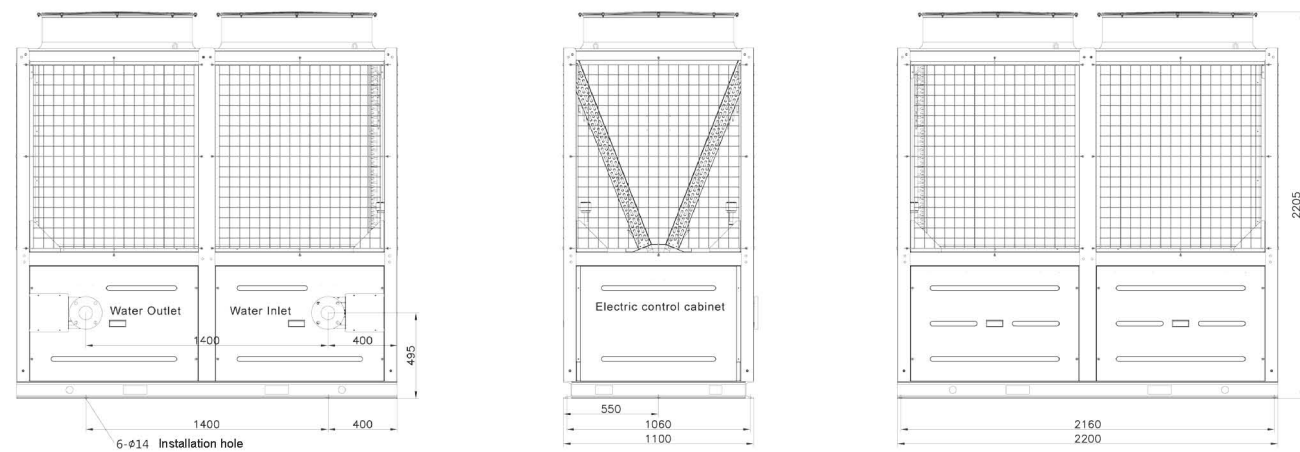

TCA201HCA/HHE

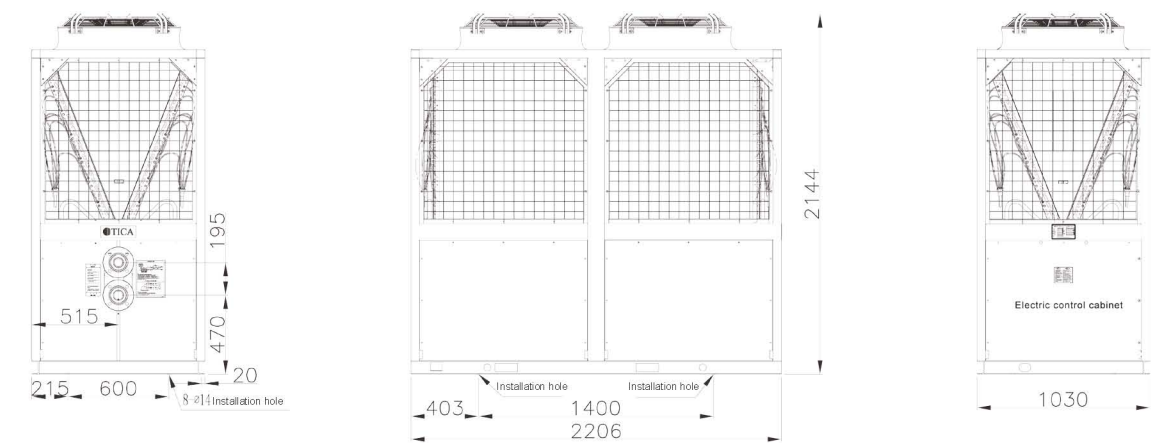

# FOUNDATION

## Program 1 (Horizontal)

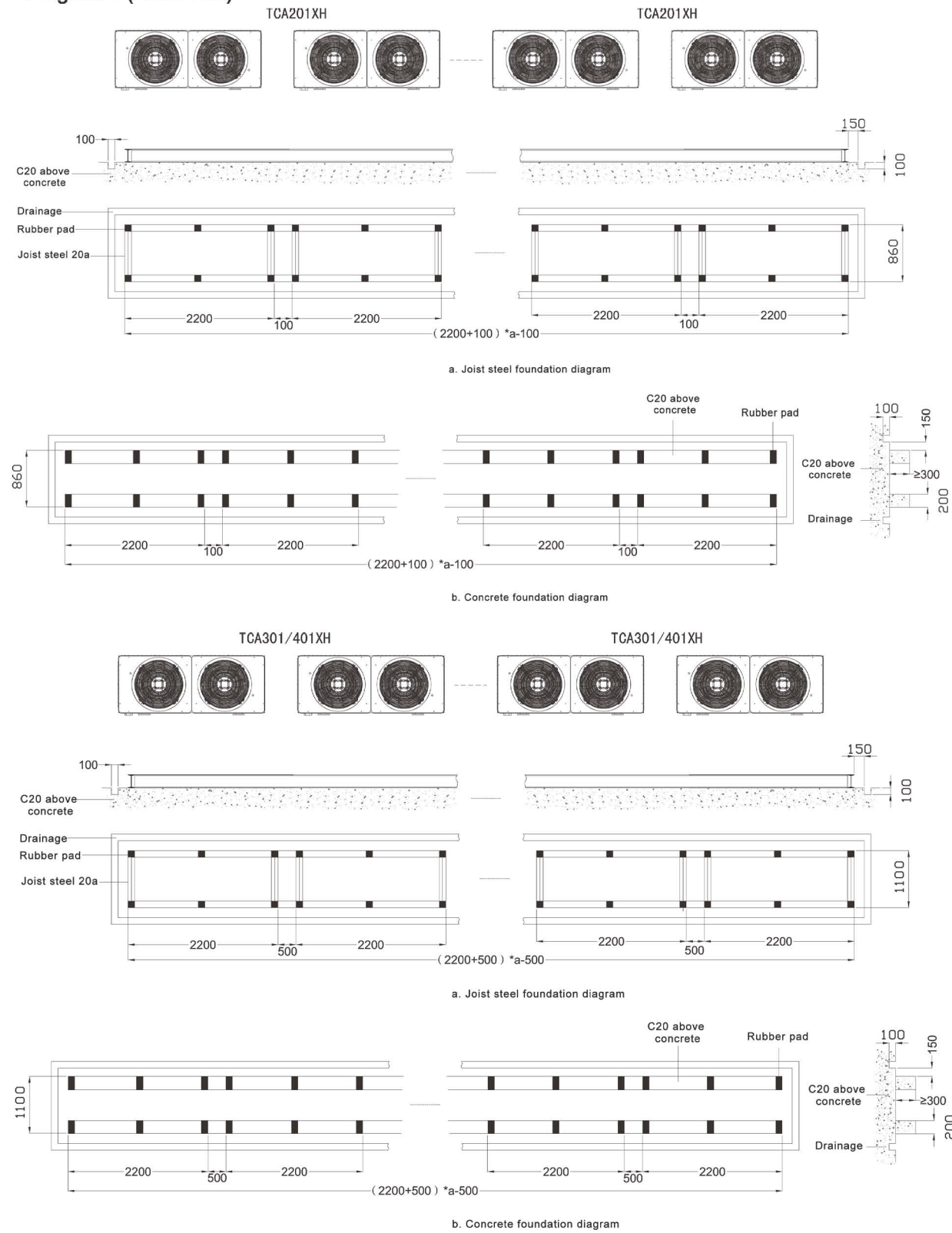

## Program 2 (Vertical)

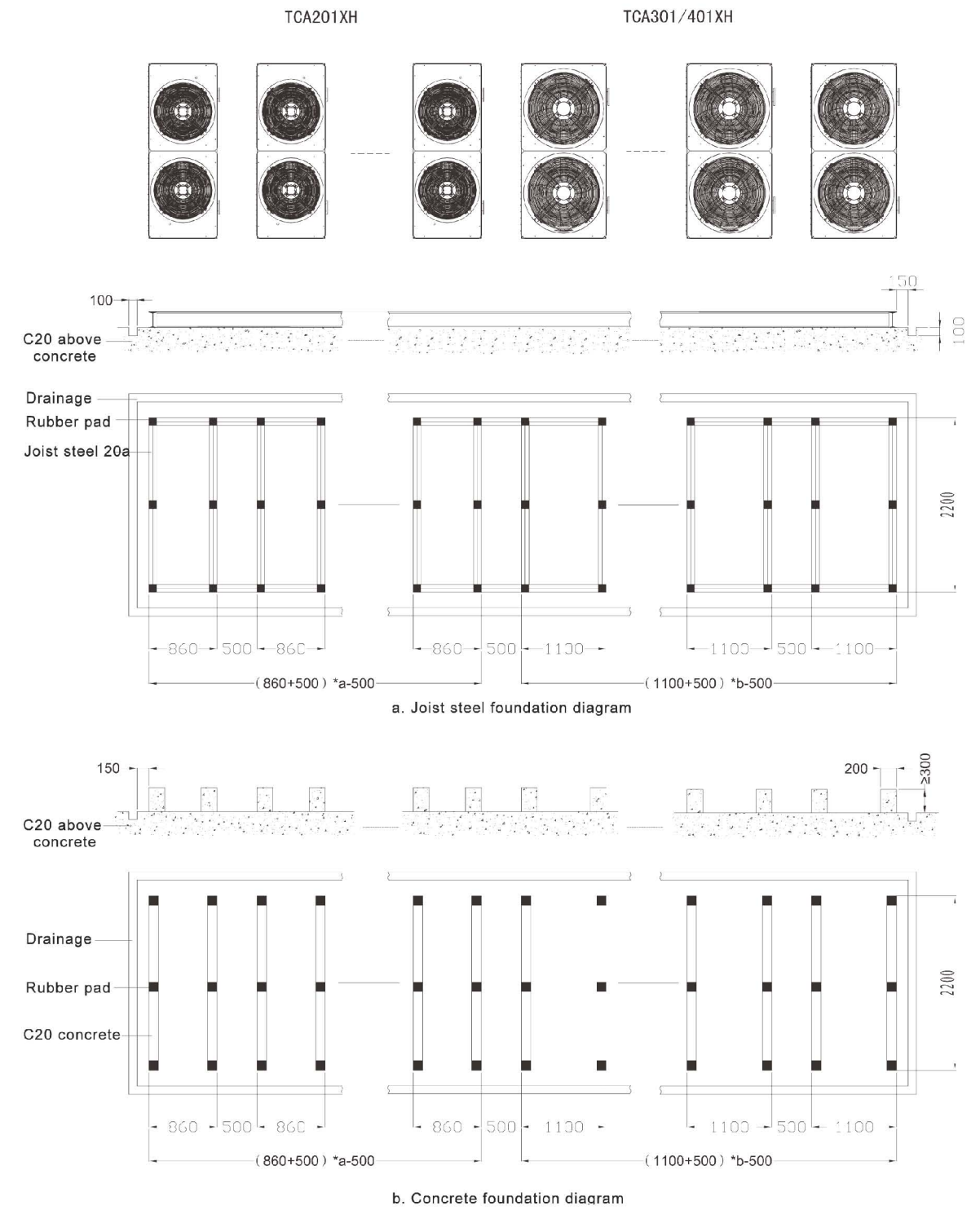



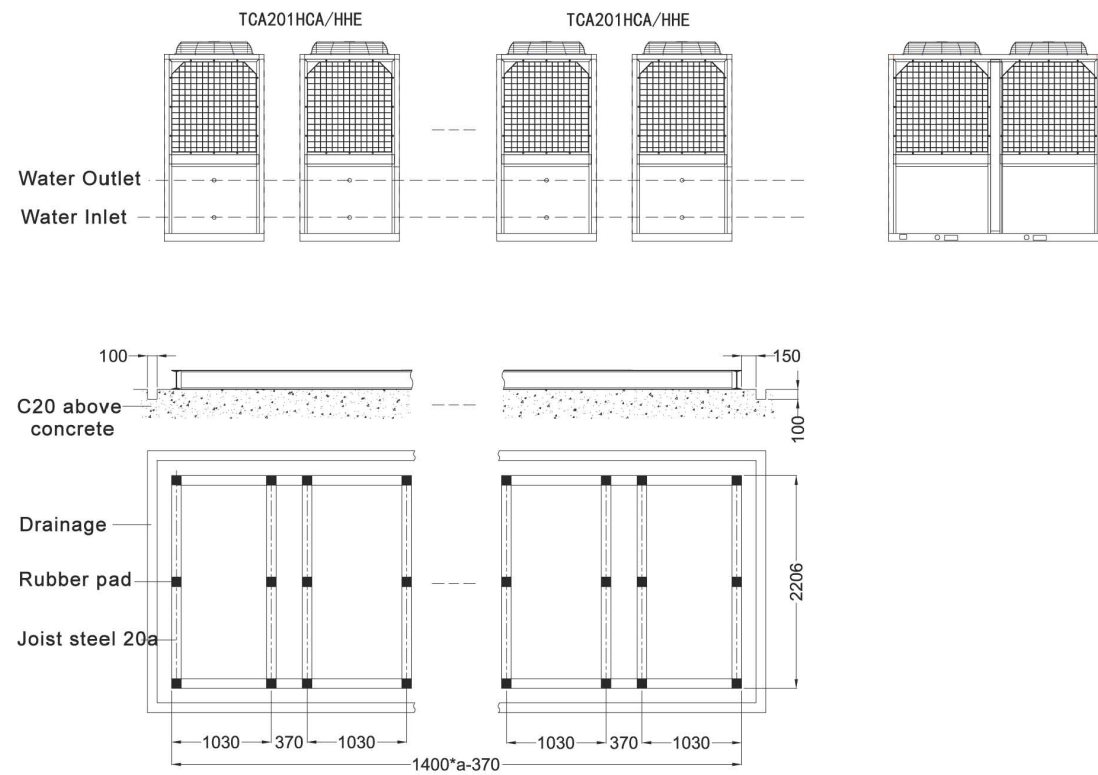

a. Joist steel foundation diagram

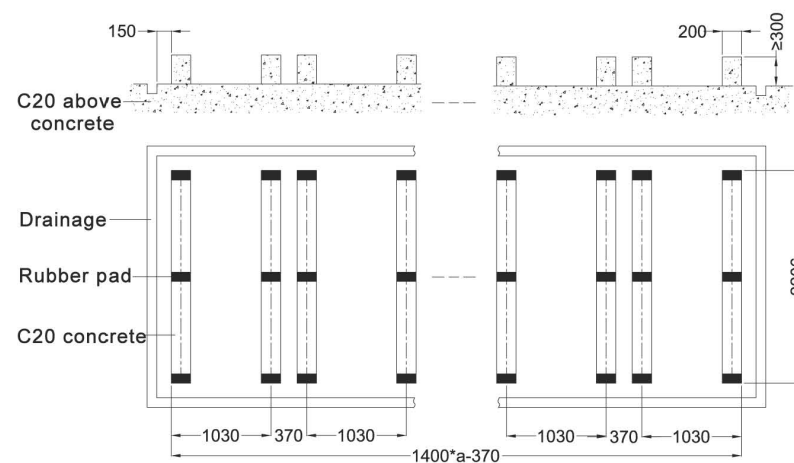

b. Concrete foundation diagram

★ Notes:

1. The installation foundation drawing is based on the TCA201 and TCA201 modular assembly as an example.
2. a is on behalf of the number of TCA201 modules.
3. The foundation is the reinforced concrete structure or groove steel, can withstand the weight of not less than 500kg/m<sup>2</sup>.
4. Between the base and the foundation of increase the rubber vibration damping pad or shock absorber, the thickness not less than 20mm.
5. The M10 bolt is adopted to fix the unit to the foundation.
6. The surface of the foundation must be horizontal. The foundation all around needs to set aside for drainage ditch.

## ELECTRICAL WIRING DIAGRAM

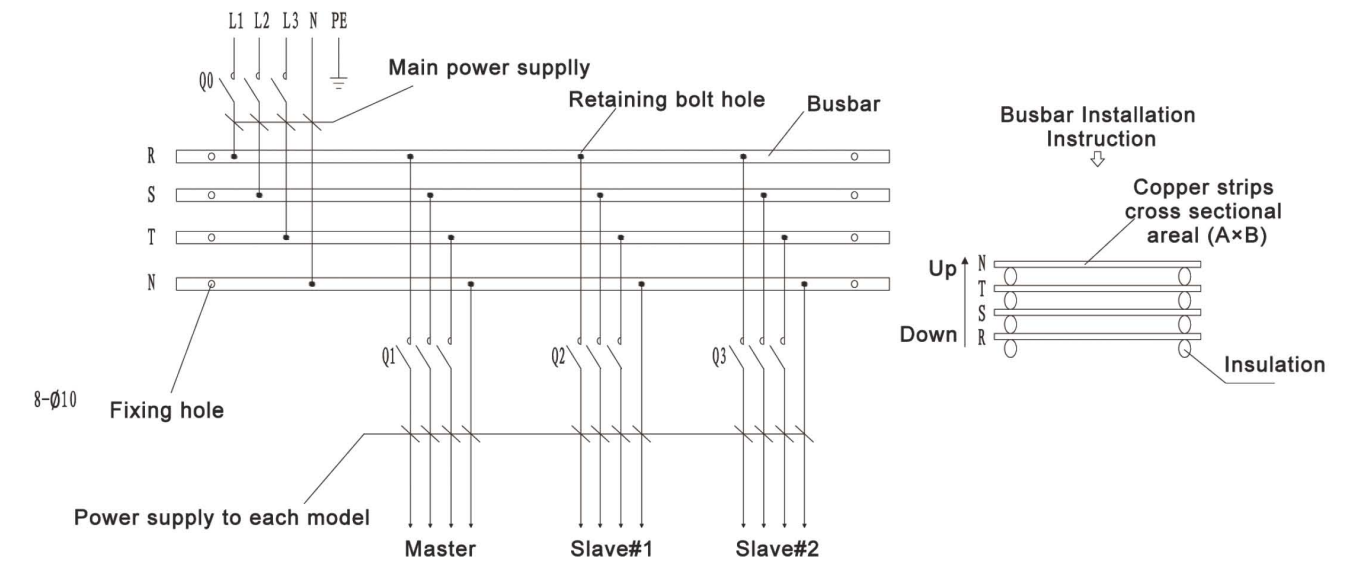

Example lifting schematic for TCA203

Model	The maximum operating current	Main power supply wiring			Communication line	Copper specifications
	(A)	Phase line	Neutral line	Ground wire	(RVVP)	(AxB)
TCA201	50	16	10	16	Communication line between Unit and remote controller is four-Cords telephone wire, factory standard configuration 30 meters. Communication line between different units is 2-cords telephone wire, the factory standard configuration 5 m.	Copper bar cross-sectional area AxB shall not be less than square number of Main power supply wire.
TCA301	80	35	16	16		
TCA401	100	50	25	25		

★

1. The power supply is 380-415V/3N ~ /50Hz.
2. Q0 and Q1/Q2/Q3 is the circuit breaker. For circuit breaker, select D type.
3. Either Q0 and (Q1/Q2/Q3) can be chosen. Q1/Q2/Q3 is more convenient for single unit maintenance.
4. During on-site installation, circuit breaker / wire / copper need to be selected according to reality, considering water pump and other load.
5. For installation of copper bar, see electric wiring diagram.
6. Copper bar isn't needed for less than two modules.
7. Terminal port is reserved in the factory, customers need to connect on job site.
8. The unit power supply wiring need to be provided by the user, the main power supply wiring must conform to the national standard of electric and electric construction.
9. The recommended power wire specifications is 70°C PVC insulated cables in the insulation of the cable laid in the insulation wall, the ambient temperature is (30°C in the air, 20°C underground) when the selection of copper core cable specifications Take the IEC\_60364-5-523 wire and cable ampacity standard), if the actual installation conditions changes, please refer to service manual according to the manufacturer's specifications, wire and wire laying conditions.
10. The selection of the power wire is closely related with local climate, soil characteristics, cable laying length. Such unit projects are usually designed by the design institute and subjected to design institute.
11. Communication wire must use STP, prohibited to be mixed with strong electricity.



## UNIT INSTALLATION

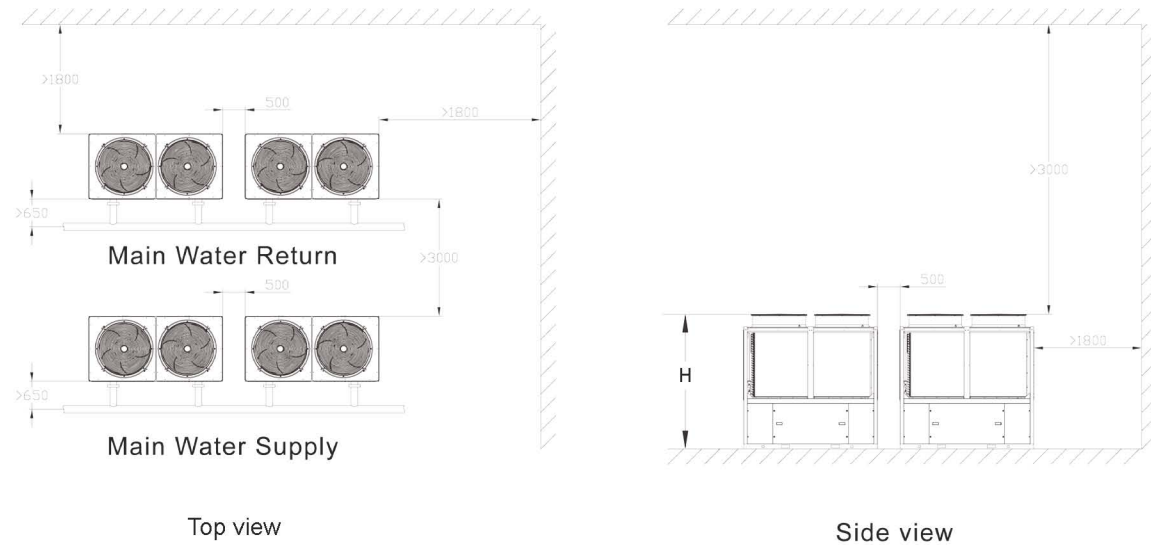

★ Remark:

- 1, 80 cold tons of the following units of water mains recommended with DN80, recommended to install for the same way;
- 80, 160 ~ 2 tons of cold water outlet pipe is recommended to use DN125, it is recommended to install for the same process;
- 160, 240 ~ 3 tons of cold water outlet pipe is recommended to use DN150, it is recommended to install for the same process;
- 240, 500 ~ 4 tons of cold water outlet pipe is recommended to use DN200, it is recommended to install for the same process;
- 5, unit water inlet and outlet connecting pipe: unit take over size reference parameter list, the total water pipe is installed according to the actual pipe.

## UNIT HOISTING

- Keep the package well from the factory to the job site;
  - Be careful when carrying the units to ensure the body vertical.
  - When lifting the unit, avoid it from hitting other objects to avoid sliding. At the same time the staff should avoid standing below or near the bottom of the unit to ensure safety;
  - In order to prevent scratches or deformation of appearance, cable section shall be placed in contact with the unit's protective pads, while support should be added between the ropes to prevent damage machinery by ropes.
  - See the parameter table for the reference weight of the hoisting steel pipe, steel rope and lifting locomotive.
- The hoisting steel pipe, steel rope and lifting locomotive reference weight see unit parameter table. Protect the inlet and outlet water pipe of the unit to avoid collision during the hoisting process.

Example lifting schematic for TCA201

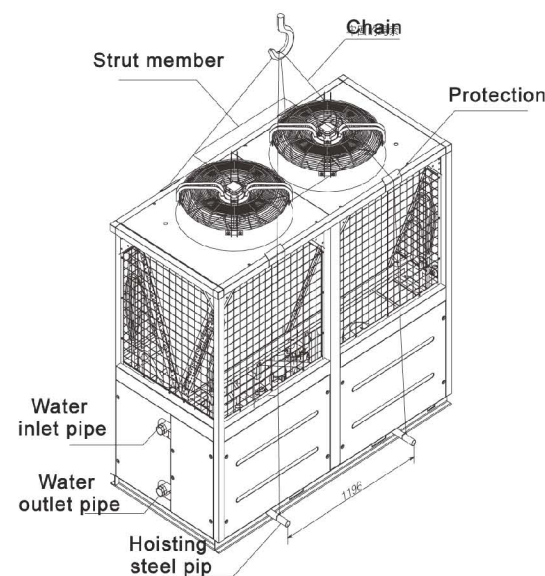

## WATER SYSTEM INSTALLATION

### Water system components

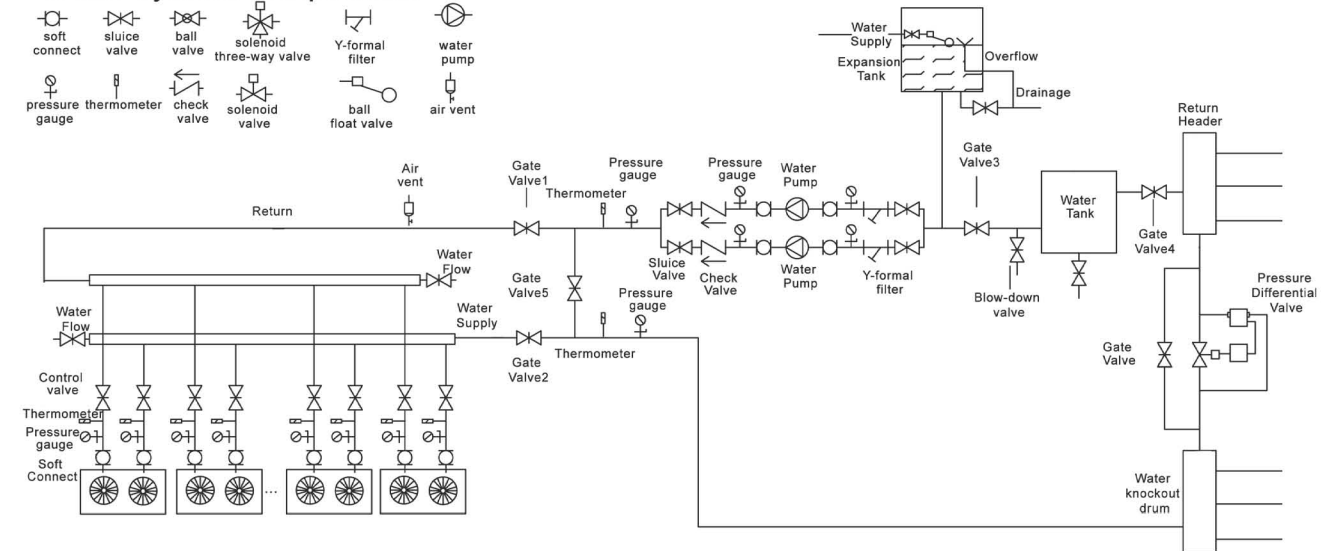

Notice:

- On-site installation of water switches is not required since they have been installed in the units.
- Multi-system water lines are applied to large projects and generally designed to realize area-based water supply. If some areas are being overhauled or closed, the loads may change significantly, so any unit can be turned off for the purpose of energy conservation.
- After the water system of the unit is installed, close the service valves 1 and 2 and open the service valve 5; start the water pump; then wash the water filter; after the water line system is clean, connect the water pipe to the main machine to be ready for normal operation.
- Water pumps shall be selected according to the water flow and required pump head and can be installed on the inlet and outlet header pipes. When the inlet pressure exceeds 1.0 MPa, they are recommended to be installed on the outlet pipe. The pump control shall be interlocked with the unit.
- The automatic differential pressure regulator can facilitate more stable operation of the whole system. Water distributors and collectors realize more reasonable water distribution in all branches.
- For shell and tube module units, it is only required to install Y-shaped water filters on inlet header pipes of units (16 ~ 20 meshes/inch recommended). Such filters shall be washed after commissioning.
- Each inlet branch pipe of units shall be equipped with a water regulating valve to allow water to flow into units at a consistent rate.
- Auxiliary thermal sources like auxiliary electrical heaters, if any, shall be installed on the outlet header pipes of units.
- To ensure balanced water resistance, units shall be subject to equal-length installation.
- The valves 1, 2, 3 and 4 shall be used as service valves while the valve 5 shall be used when the pipes shall be cleaned for initial system commissioning or when the terminals and pipes are subject to water treatment. In such cases, the valves 1 and 2 shall be closed while the valves 3, 4 and 5 shall be opened and the water pump shall be started.
- The size of inlet and outlet collector pipes of units shall be so designed to allow the water flow rate of less than 1 m/s and shall be greater than that of the water system loop pipes connecting with such collector pipes



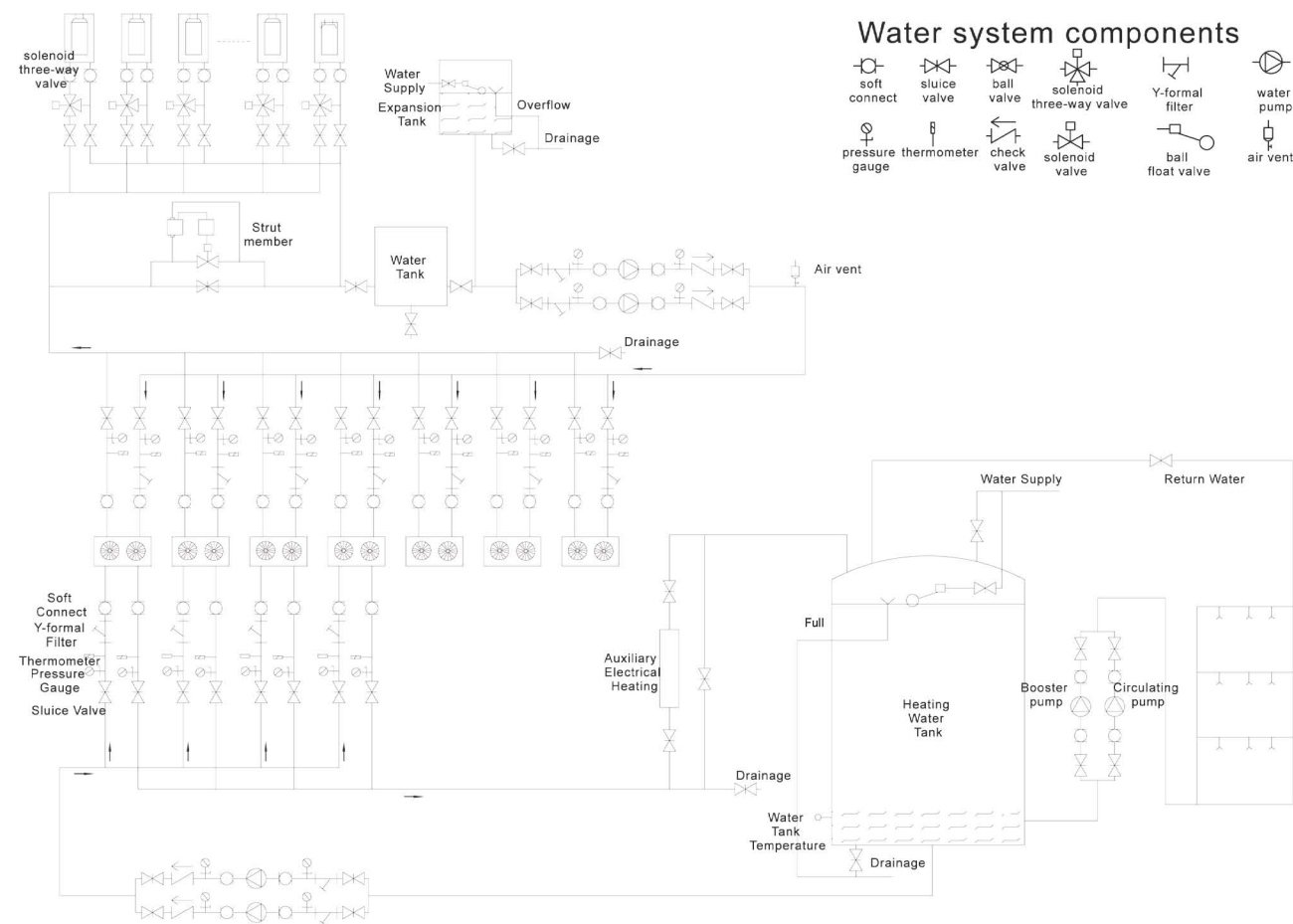

Notes: (installation requirements for domestic hot water system of units)

- To ensure balanced water resistance, the water system shall be subject to equal-length installation in case of parallel connection of several units.
- It is recommended to use externally galvanized internally plastic-lined pipes or stainless steel pipes, instead of PPR pipes, for the hot water system.
- In areas where water harness is great, water treatment devices shall be provided on the water-refilling end.
- The hot water circulating pump shall be installed at the same level with the hot water tank or at a position lower than the lowest level of the water tank.
- The A/C circulating water pump and hot water circulating pump shall be interlocked with the main machine and kept energized.
- The domestic hot water tank shall be checked frequently for its normal water supply capacity.
- All hot water pipes are recommended to be provided with rubber insulation materials. The thickness of the insulation layer shall not be less than 20 mm (if other insulation materials are used, their insulation performance shall not be inferior to that of the foresaid materials); for the insulated outdoor hot water pipes, the insulated materials shall be provided with a protective layer made of galvanized sheet iron or aluminum.
- It is recommended to install the water tank near the hot pump unit as far as practicable, provided that ventilation surrounding the hot pump unit is not deteriorated, so as to reduce thermal loss of pipes.
- It is recommended to install auxiliary electric heaters (if any) at a height lower than the water tank.

## PRECAUTIONS FOR USERS

### Installation requirements for water system

- Circulating water shall be softened water.
- The water system shall be provided with safety valves and automatic water-refilling valves.
- The water flow rate shall not be lower than the normal value on the unit nameplate.
- The automatic air bleeding valve shall be provided at the highest point of the water system.
- A proper water drain valve shall be set at the lowest point of the water system.
- The water system pipes shall be provided with expansion water tanks which can adapt to volume changes caused by water temperature changes.
- The water system pipes shall be provided with bypass pipes which can be connected with water lines of the main machine only after the water system is confirmed to be clean.
- The water system shall be clean frequently to prevent impurities from entering the evaporator and damaging the unit.
- The total capacity of the water system shall be 10 L/kW. In case of insufficient capacity, an energy storage water tank of proper size shall be provided so as to prevent water temperature changes and frequent startup and stop of the unit.

### Maintenance

- The unit should be equipped with the special power supply. The supply voltage fluctuates +10%. The automatic air switch should be used. The setting current is 1.5 times of the running current of the unit. The inverse phase protection devices are installed. Never apply the knife switch unit.
- At the time of the first application every season, the unit must be electrified and preheated for 24 hours and start later. If the single cooling unit will stay for a long period of time, the water in the unit and the pipeline must be drained completely. After the heat pump type units stop, the master controller should correspond with the host and the power supply can never be disconnected to avoid the water pipelines or the unit frozen (the controller in accordance with the environment temperature and the temperature of the incoming water and the outgoing water automatically implement the anti-freezing functions. As for details, see the user manual)
- The host switch can not be operated quite often. It can be operate 6 times per hour at most. The electric control cabinet should avoid humidity.
- Keep the unit in good ventilation environment constantly. The air side heat exchanger should be cleaned regularly.
- The water system should be equipped with the expansion tank. The recycling water should be clean and tidy. At the time of operation, a sufficient water flow (as for details, see the nameplate) should be maintained, or the water side heat exchanger would be frozen. And the filter should be cleaned regularly.
- The water system should be equipped with the expansion tank. The recycling water should be cleaned regularly.
- Appoint the specific person to maintain and record.
- TCA201/301/401XH can not conduct the refrigeration when the environment temperature is lower than 5°C. In case that it is necessary to conduct the cryogenic refrigeration, please indicate it on the purchase order.



## DAILY MAINTENANCE

Air conditioners are equipment for air conditioning. The users are recommended to record routine operation date of such equipment and provide regular maintenance.

Before initial service, it is required to check if terminal equipment and other components of the water system work normally.

When the equipment is used, the following maintenance system is recommended:

Description of unit maintenance	Standard maintenance interval	
	Quarterly	Semi-annual
1. Check if the power line (from the power distribution cabinet to the unit) is loosened or damaged.		★
2. Check if there is any abnormal noise when the unit is in operation.		●
3. Check if the air-side heat exchanger has to be cleaned (dust on the surface, impurities, etc.).	●	
4. Clean the filter screens of water filters inside and outside the unit and immediately replace damaged filter screens.	★	●

Note: If necessary, the maintenance system before the equipment is put into service can apply. See Installation Instructions for each model.

★ Note:

1. Maintenance to be implemented by users: Mandatory inspection items —●; recommended inspection items —★
2. Vulnerable parts necessary for maintenance shall be purchased by users from TICA.
3. The maintenance intervals above are suitable for normal operation, and in case of operation in severe conditions, the interval can be adjusted as required.





---

NANJING TICA AIR-CONDITIONING CO.,LTD.  
Add: No.6 Hengye Road, Development Zone, Nanjing, China  
Post: 210046  
Tel: +86-25-85326977  
E-mail: [ticaorc@ticachina.com](mailto:ticaorc@ticachina.com)  
Website: [www.ticachina.com](http://www.ticachina.com)

---

DISCLAIMER NOTE: Data provided herein are not binding and might change without prior notice.